

PCC 57.002 | PCC 115.002

# COMPACT CRAWLER CRANES

LIFETIME EXCELLENCE



## TRUE LIFTING POWER, MODULAR AND VERSATILE WITHIN THE TIGHTEST SPACES

A compact crawler crane from PALFINGER is the innovative solution to operate fast, efficient and precise with only one solution. Get with this unique compact crawler crane solution from PALFINGER a much smaller carbon footprint by reducing the fleet, transport costs and many more.

The compact allrounders are designed for lifting applications where other solutions are impossible. Especially in tightest spaces the compact crawler cranes running at peak performance.

Decades of experience in crane combined with latest market requirements allowed our team to secure every last kilogram of lifting capacity out of the compact PALFINGER Crawler Cranes.

## LIFETIME EXCELLENCE MORE THAN A PROMISE

With LIFETIME EXCELLENCE we guarantee top performances from the PALFINGER Crawler Crane – with no compromises. During the development stage it was important to combine the most cost-effective and reliable components to create an innovative solution for highest utilization.

### GOING EVERYWHERE & REACH ANYTHING

- Detachable crawler module for reaching any space by shifting  
The crane can be separated from the crawler module, lowering the total height, and unveiling impressive access in lifting under structures.
- Power crawler module for powering the crane and or transporting goods with towing hook.
- Shifting of entire machine, to optimize position and lifting moment in confined spaces.
- H-frame stabilizers offer no-limitation between obstacles.
- Flexible counterweight vs. stabilizer setup for 360° stability
- Powerful hydraulic winch
- Advanced features of 90 years crane experience
- Diesel and electric drive line are possible

## ONE FOR EVERYTHING

MOBILE CRANE

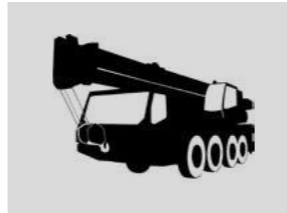

CRAWLER CRANE



MINI CRANE



TRACTOR



PALFINGER CRAWLER CRANE

TOWER CRANE



SPIDER CRANE



TRANSPORT



# APPLICATION AREAS OVERVIEW



PCC 57.002

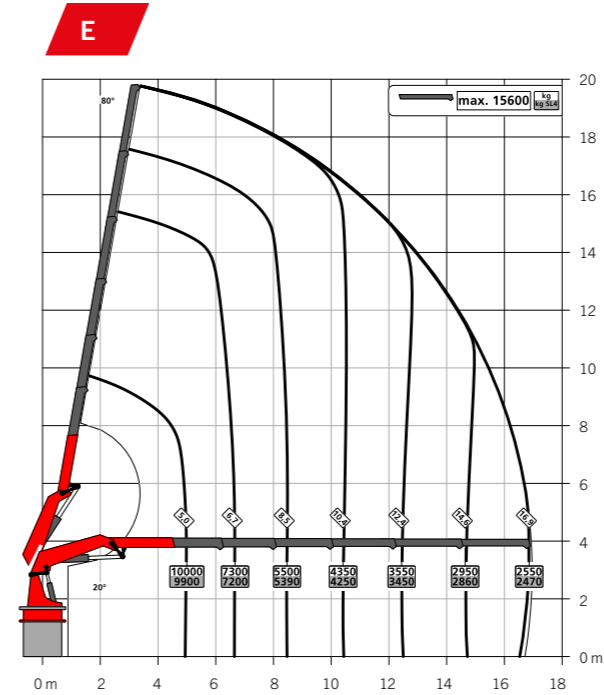

E PJ125C E

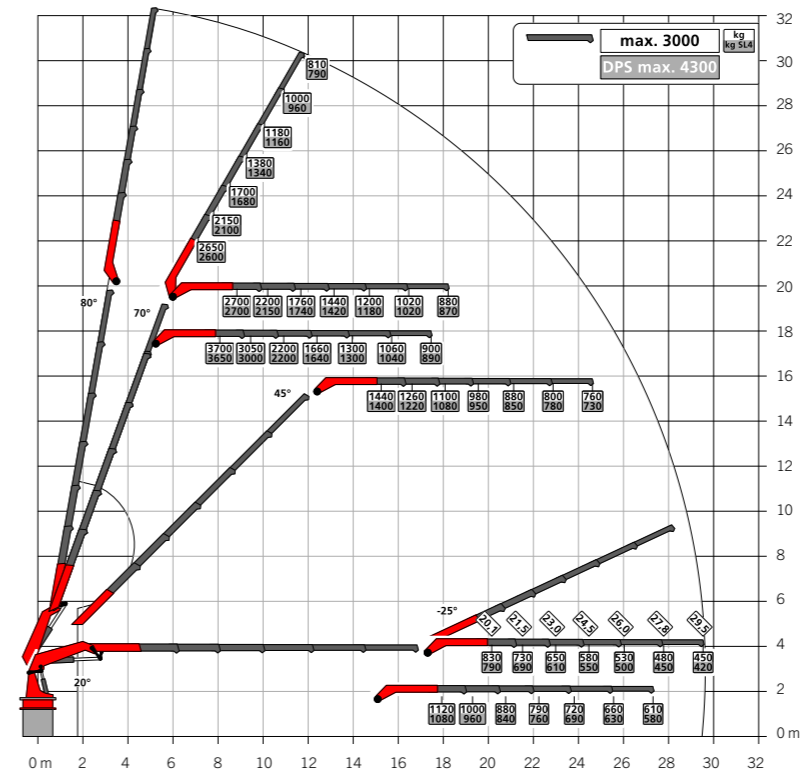

**PCC 115.002**

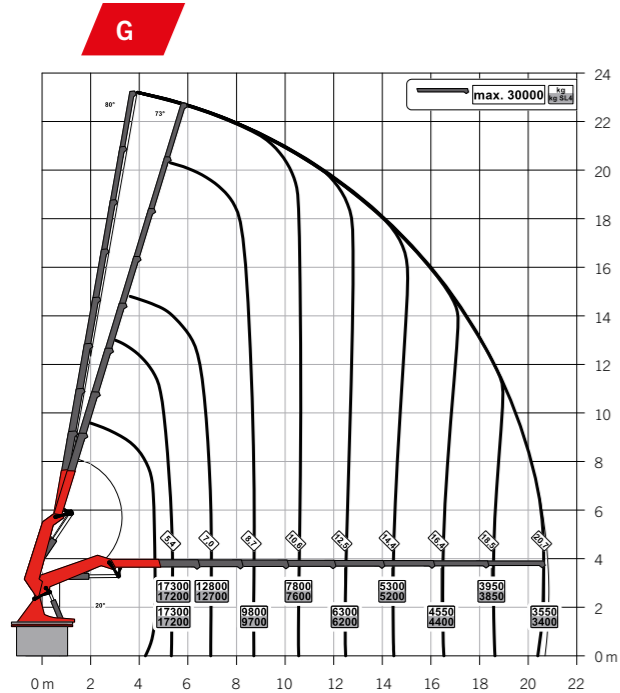

**PCC HIGHLIGHTS**

**KNUCKLE BOOM**

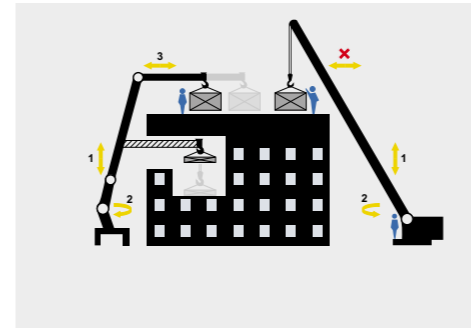

The PALFINGER knuckle boom allows the load to be positioned or lifted over a roof and inside a building with the full-powered boom, jib or optional winch. The Palcom P7 remote enables easy operation while keeping the load constantly in view for maximum safety and efficiency. In most cases no signalman is needed.

- Overstretching boom 14° and jib 25° to access difficult spaces (9° and 25° for PCC115.002)

**DEMOUNTABLE CRAWLER UNIT**



Demounting is the ability to separate the Crawler Power Unit from the Crane Module. The crane module and the crawler power unit can operate independently as long as they are connected with a hydraulic/ electric powerline. An optional power pack or a truck can take over the power unit function of the crawler.



**G PCJ170 E**

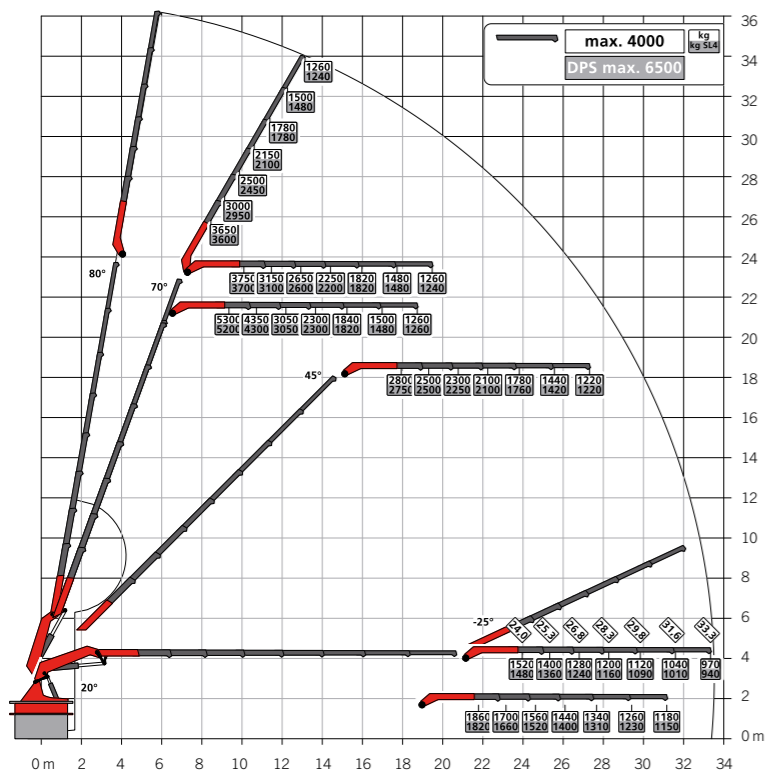

**SHIFTING: Enhance Possibilities**



Shifting is the ability of the crane module with or without crawler tractor to move longitudinally and sideways: it can literally walk. Demounting the crawler power unit significantly reduces the crane module height allowing it to pass through low entrances. The machine can also move into corners and over obstacles which even with crawlers would be impossible. (PCC57.002 - 2.1 m, PCC71.002 – 2.5 m, PCC115.002 – 2.6 m)



**STABILITY 360°**



The heavy-duty outrigger system ensures 360° stability. Even with partly retracted outriggers, virtually full lifting capacity is attained when using the hydraulic detachable counterweight. An ideal solution for the most challenging lifting tasks.

# PCC HIGHLIGHTS

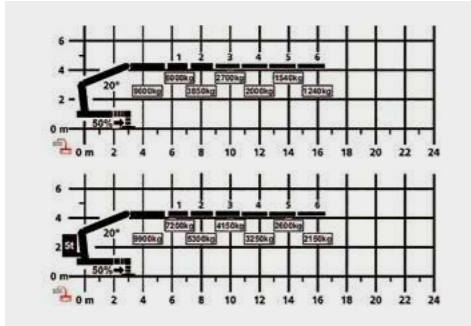

## DETACHABLE: Counterweight

The machine works with a set of two counterweights, where one is detachable, and column mounted: 5 tonne for the PCC 57.002 and 8 tonne for the PCC 115.002. The second one is the function of the crawler module acting as detachable counterweight too. The unique possibility is that the machine can have a 100% stability even when the stabilizers are close to 50% retracted.

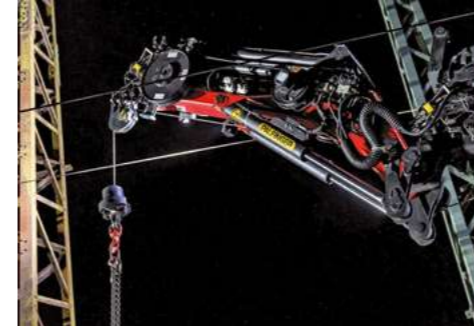

## LIFTING WITH HOOK OR WINCH

The PCC can perform lifts directly with a hook on the boom tip and the fly jib or with a powerful 3,5 t winch.



## HEAVY DUTY: Stabilizers

Full steel guided outrigger jacks eliminate movements when being jacked-up. With automatic leveling functions the machine can be positioned on inclined slopes as much as 8%. The lifting function easily lifts the crane from the crawler module, when detaching or loading the machine on a trailer.



## NO DAMAGE: PU-Shoepads

Highly resistant PU pads can be easily mounted and demounted when switching between indoors and outdoors.



## DRIVE LINE: Diesel or Electric\*

Powerful diesel engine to handle off-road conditions or an electric drive to work in sensitive areas - everything is possible with the PALFINGER Crawler Cranes. It combines the best of two worlds. With the PCC lifting applications can be done continuously with just 15 kW of electric power. The electric drive has no exhaust of noise and fumes on site. A safe environment for the operator and others.

\*In Electric drive, certain lifts and speeds are limited due to leaner setup of the separate hydraulic pump.



## EASY TRANSPORT

The compact PALFINGER crawler crane can easily be transported close to the job site using a trailer by detaching the crane from the crawler module. The self-propelled lifting solution easily covers the last few meters to the respective area of application.



## WORKMAN BASKET

Beside the functionality of a crane the PCC, can be equipped with an EN280 certified workman basket for easily outdoor or indoor maintenance.



## SIDE-LOADING FORKS

Mechanically connected forks allow the PCC to transport long pieces of up to 4.000 kg / 8.000 lbs.



# PCC HIGHLIGHTS



## P-FOLD

Automated folding function with only one lever movement. P-Fold increases speed and eliminates damage.



## PICK & CARRY

Greater operational flexibility through safe movement of loads and workman basket.

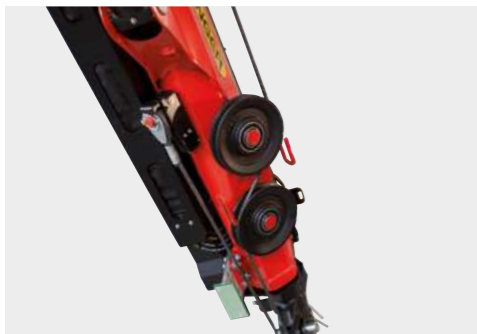

## RTC (rope tension control)

The Rope Tension Control keeps the lifting cable under tension when operating and folding winch and jib.

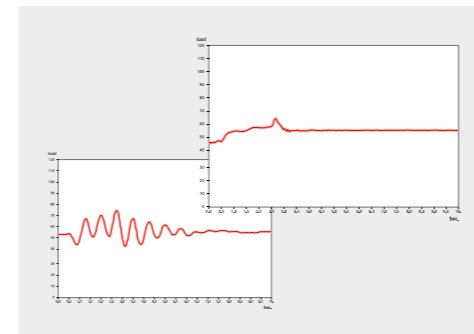

## AOS (Active Oscillation Suppression)

Eliminates physical swinging in the boom by active hydraulic suppression. Increases safety and enhances comfort.

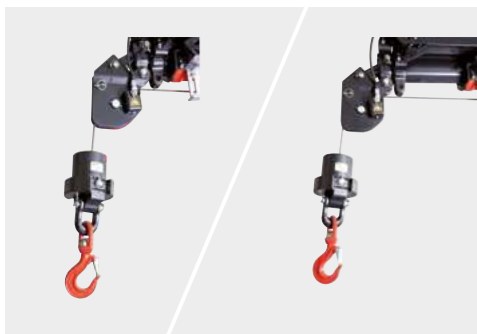

## SRC (synchronized rope control) on optional winch

The Synchronized Rope Control automatically maintains load height when extending or retracting boom and jib. Increases safety and enhances comfort.



## PALTRONIC P150

with PALcom P7 and P3 remote controls

The proven PALFINGER electronic heart, real-time processing of thousands of parameters to assure safety, maximum lifting performance and easy control. The PALcom P7 remote with excellent haptics and visuals for the crane. The separate P3 to operate the power crawler unit.



# 3-IN-1 SOLUTION

## PCC ON TRUCK OR CRAWLER

Installed on a truck the crane unit of the PCC has increased utilization due to multiple usability. The connection and disconnection of the crane unit from the respective carrier vehicles is comfortable and easy. The allrounder could be used than on a truck, crawler or also stationary with and without an additional Power Pack. The solution can be used without special road permit on trucks thanks to compact design and well balanced dead weight.

### H-Frame

The Outriggers have a H-frame setup. Under any circumstances the optimum stabilization position can be reached. Around corners, between obstacles, auto-stabilizing on up to 8° on inclined surfaces, moving over ditches or fences, avoiding roadblocks when performing jobs in infrastructure.

Different than a loader crane, the PCC lifts its entire structure off the ground, whether it is the crawler module or the attached truck, because it acts as a center counterweight delivering a 360° stability.

In both configurations the H-type outrigger frame allows to shift the crane to the load, or away from obstacles, allowing much higher duties in tight spaces.



# PALFINGER CUSTOMERS #ONTHEJOB



## NOT ONLY IN THE INDUSTRY AT HOME

The PALFINGER PCC 57.002 crawler crane performs at its best, when it comes to coping with steep slopes where the ground is unstable. Not every crane is capable of this! It also demonstrates its versatility when erecting power poles in the mountains of St. Johann im Pongau, Austria.



## EMISSION-FREE & EFFICIENT IN USE

Compact and agile, strong and stable - the PALFINGER PCC 57.002 crawler crane lifts even the heaviest construction components on site with ease and precision for the infrastructure of the future underground pumped storage power plant of ÖBB-Infrastruktur AG in Tauernmoos. The environment and the construction workers inside the cavern benefit from the emission-free and silent operation of the compact crane.



## NIGHT SHIFT LEIPZIG: EVERYTHING WELL ON TRACK

The main station of the trade fair metropolis in Saxony is being modernized. In order to keep this busy rail junction operational, work is also being carried out at night on closed tracks with deactivated overhead lines. A PALFINGER PCC crawler crane is being used on a challenging STRABAG Rail construction site for Deutsche Bahn.



## PERFORMER IN DIFFICULT TERRAIN

The PALFINGER crawler crane is a performer in difficult terrain - and that comes as standard! He is in top form where others have had to give up for a long time. Powerful and agile, it manages inclines of up to 60%. Optional climbing aids and wider base plates provide additional stability.



# TECHNICAL SPECIFICATIONS

	PCC 57.002	PCC 115.002
<b>a</b> Length [mm]	5,880	7,530
<b>b</b> Width [mm]	1,900	2,100
<b>c</b> Height [mm]	2,830 (3,280 with jib)	3,260 (3,660 with jib)
<b>d</b> Wheelbase [mm]	2,515	3,000
<b>e</b> Ground clearance [mm]	200	275
<b>f</b> Shoe width [mm]	400	500
<b>g</b> Approach angle	17°	17°
<b>h</b> Height without crawler module [mm]	2,080 (2,540 with jib)	2,359 (2,775 with jib)
Length extended [mm]	7,547	9,007
Width extended [mm]	7,140	7,880
Max. lifting moment [tm]	52.7	104.4
Max. rated capacity [kg]	17,900	30,000
Weight crane module [kg]	12,235	21,420
Weight crawler module [kg]	7,000	10,000
Weight CW [kg]	5,500	8,500
Weight Jib [kg]	1,285	1,780
Engine	CAT3.6 75 kW / 400 V, 32 A	CAT4.4 110 kW/400 V, 32 A
Travel speed [kmh]	0-5	0-5
Max. gradient [%]	60	60
Max. crawler pull [kg]	10,000	10,000
Classification	HC1 HD5/S1 EN12999	HC1 HD5/S1 EN12999
Slewing area	continuous	continuous

## DIMENSIONS

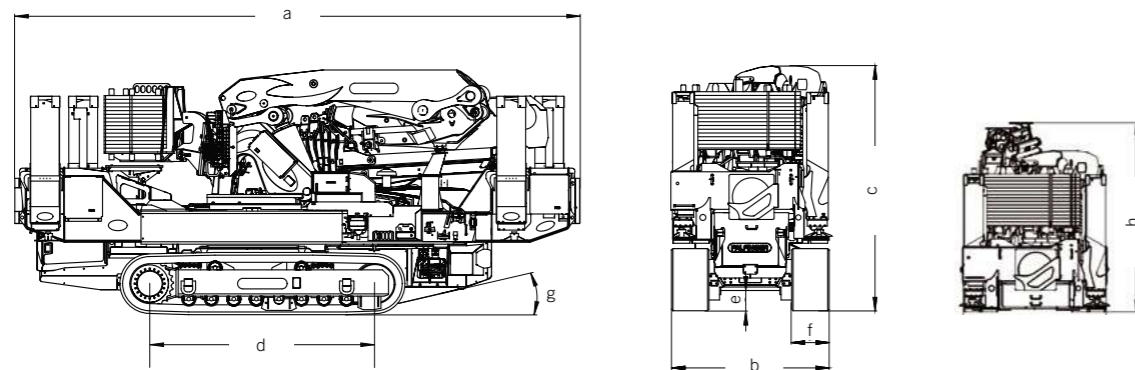

# PALFINGER CRAWLER CRANE SERVICE AND TRAINING

**We take the lead in innovation and will support you during the entire product life cycle.**

At PALFINGER Crawler Crane, service and customer focus are a top priority. With our service support points around the world, we are always close by. Rapid, professional and straightforward support for technical questions is routine for us. We think and act in a way that is customer-oriented, flexible and efficient. Our highly qualified technicians with many years of experience handle every service call with motivation and enthusiasm and make dealing with your concerns their own personal mission.

The PALFINGER Crawler Crane service team is with you from the beginning. At the handover in our factory, you receive comprehensive initial training from our Training department. Our technicians are happy to assist you with your first jobs on site, so that you can gain confidence and become independent in handling the equipment as well as achieve your desired goals as efficiently as possible.

All repairs, services, annual inspections and training courses are carried out and coordinated by our Service and Training team.

**[crawlercrane@PALFINGER.com](mailto:crawlercrane@PALFINGER.com)**



