

HOEFLON®

C6e



Hoeflon. Good job.

Key specs

- Fully electric powered
- The most compact mini-crane
- Maximum capacity with minimum weight
- Flexible outrigger system
- Removable counterweight

Silent power

Electric machines are sustainable. That's a fact. But Hoeflon customers cite the C6e's silent operation as an absolute plus.

Previously, only the sound of a diesel engine could be heard. Now the C6e works silently. Communicating alongside a running machine is now effortless. The C6e is not only quiet but powerful too. That is obvious from the high capacity of this tremendous machine.

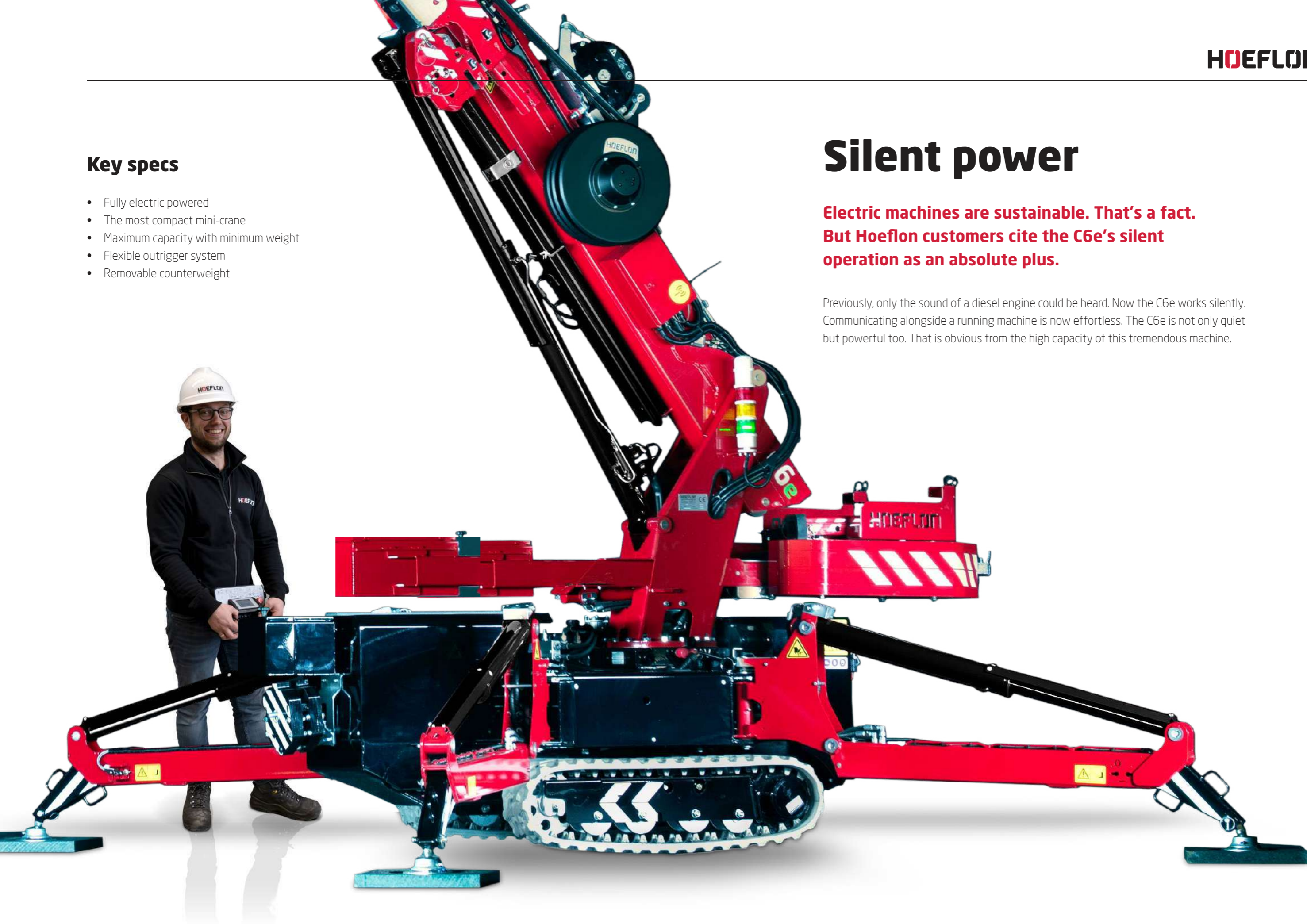

CO₂ neutral!

100% Electric

The Hoeflon C6e is a fully electric mini-crane. That means CO₂ neutrality when you work with this machine. In more and more places, this is a firm requirement.

A mini-crane is ideally suited for all-electric operation, because a mini-crane is often used inside or near a building where electric power is available. There are also places where there is no electricity. Fortunately, there are mobile battery systems available that provide you with temporary power.

Construction

We use LiFePO₄ battery technology. This composition has many advantages, especially when it comes to safety compared to other Li-ion batteries. The LiFePO₄ battery cells cannot ignite or explode during charging/discharging. The battery has a long service life and can be charged and discharged frequently with minimal performance degradation. The composition is environmentally friendly, and high and low temperatures hardly affect the battery cell.



Information about the electric crane

At a 60% duty cycle, you can run the crane for eight hours. At lower temperatures the capacity of the battery decreases and you need to recharge it more quickly. The crane is fully charged again in five hours.



capacity of up to 8 hours



- ✓ Charge with a generator (at least 3 kW)
- ✓ The C6e has three possible charging rates: 2.5, 5 and 10 amps.

- You can work and charge at the same time. The mini-crane recharges faster than it discharges.
- At low temperatures the battery warms itself up to 0 °C, at which point it starts to charge.
- The C6e can be used at temperatures of -10 to +40 °C.
- The battery's state of charge is shown on the machine.
- Recharging is possible with 230 V and 110 V single phase.

On the move

From A to B with the Hoeflon C6e

Little powerhouse. At 2,850 kg, the C6e can definitely be called that. The crane can be transported with a pick-up truck or heavy duty van. The C6e gets the maximum capacity out of a 3-tonne mini-crane.

The C6e's compact size allows it to easily squeeze through tight spots. The crane is just 76 cm wide and its height can be reduced to 1.86 m. So narrow passages are no problem at all. Whether you are hoisting a jacuzzi into a backyard or placing a complete production line in a factory, the C6e does it all.

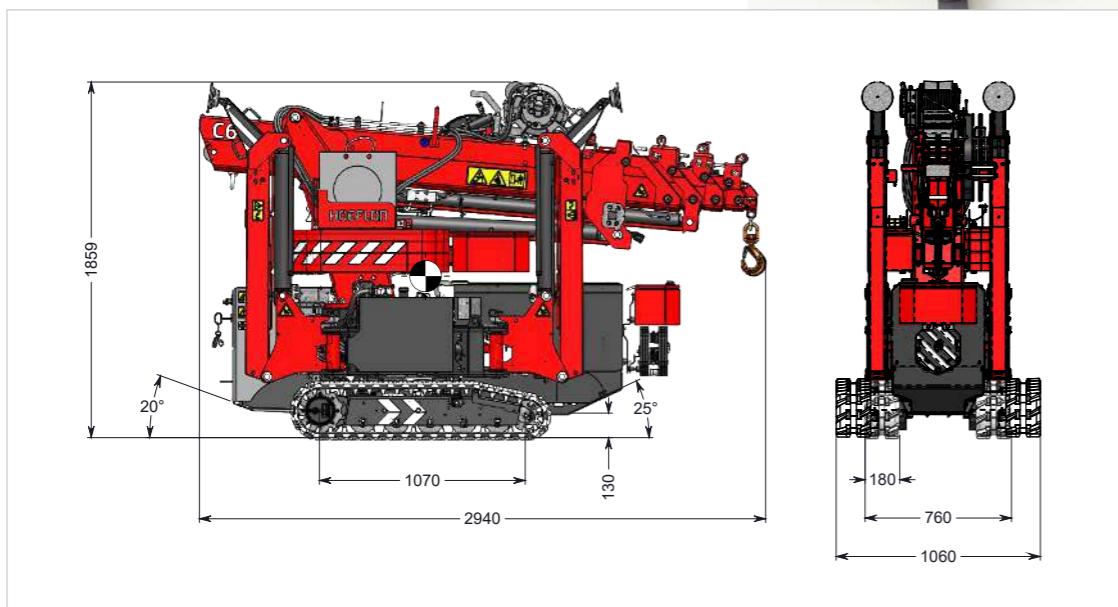

Endless positioning
with the Hoeflon C6e

You're standing strong

Each leg of the C6e can be positioned separately from the other legs. The C6e has hydraulically adjustable legs, hydraulically extendable legs and folding legs. This allows you to set the outriggers at any angle and extend them to fit the space you have. You can also easily overcome uneven terrain or obstacles.



Technical specifications

Positioning

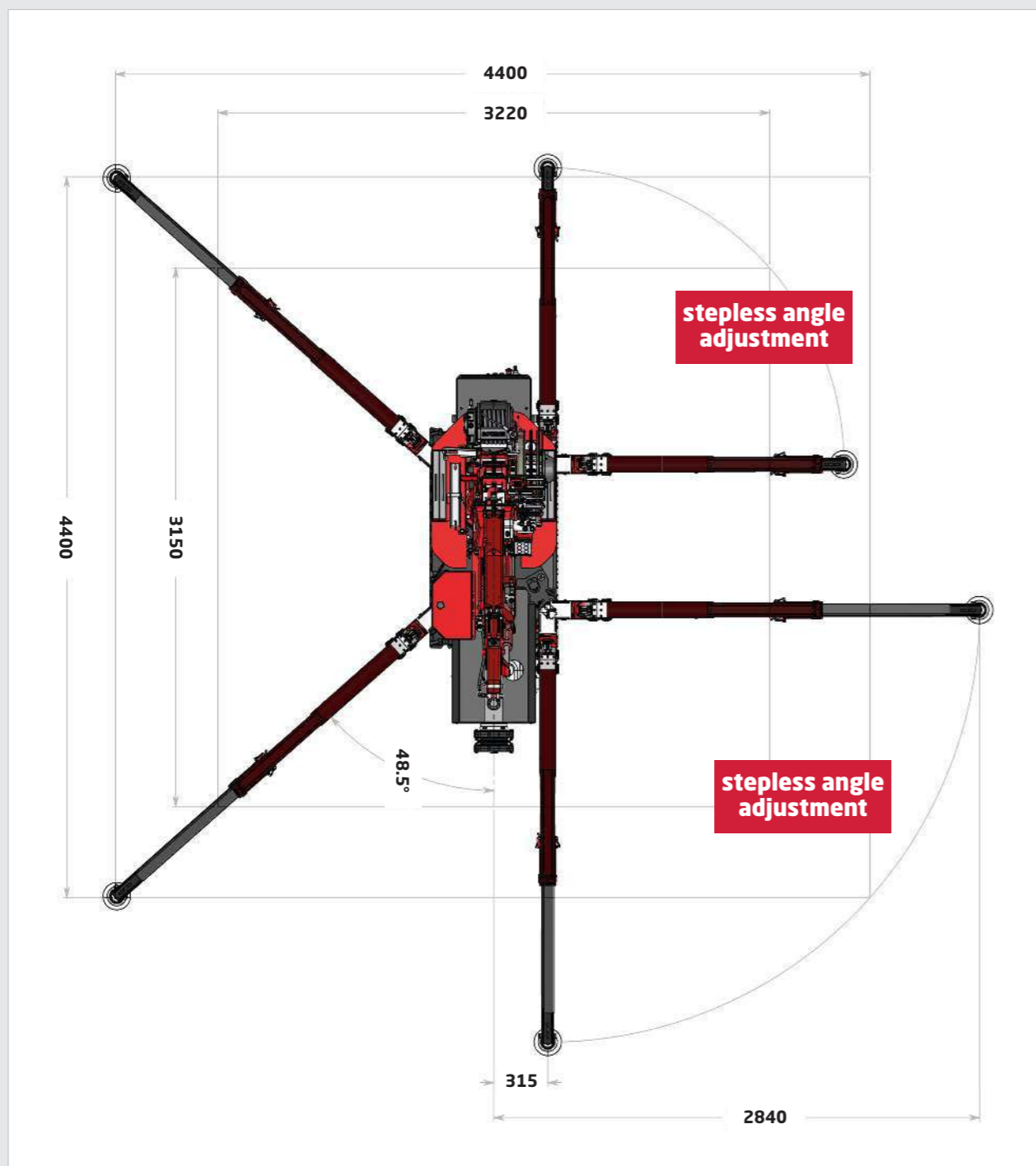

1 Hydraulically extendable legs

The C6e's legs are hydraulically extendable. So you can attain the maximum capacity in any situation.

2 Hydraulically adjustable legs

The C6e's legs are hydraulically adjustable. This means you can always place the outriggers in the optimum position to set up the crane perfectly in any workplace.

3 Folding legs

The C6e has folding legs. Normally, the leg is low to the ground so it can extend under obstacles. When placing the outriggers over an obstacle, pull out the folding leg. The folding leg also comes in handy on uneven terrain. This enables you to compensate for a height difference of up to two metres.



At work

Lifting and hoisting

Jib

The jib weighs 150 kg and has a maximum capacity of 900 kg. The jib can lift at angles of up to 15 degrees in the negative direction. This means the jib can pass through the dead point.



Adjustable section with manual jib extension

The adjustable section with manual jib extension is used as a strong jib on the main boom. This adjustable section has a capacity of three tonnes. It can also be used as a jib extension. The manual jib extension is used for placing glass. This is done extremely gently thanks to the rubber head. The weight of the adjustable section with manual jib extension is 17 kg.



Winch cable capacity

There are two winch options for the C6e. The 1000 kg winch with 40 m of cable is standard. A second possibility is the 800 kg winch with 80 m of cable. By means of reeving you can reach the maximum capacity of 3000 kg with both winches.



Head dimensions

The C6e has a compact head. This makes it possible to work in confined spaces.

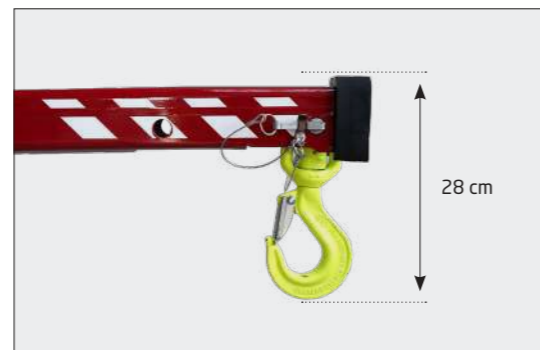

Lifting point

The crane has one lifting point for lifting the crane in the transport position.



Work lights

The C6e has two work lights as standard: one at the bottom of the jib and the other at the bottom of the main boom.

Winch head and adjustable section

There is room on the side of the main boom to hang the winch head and adjustable section.

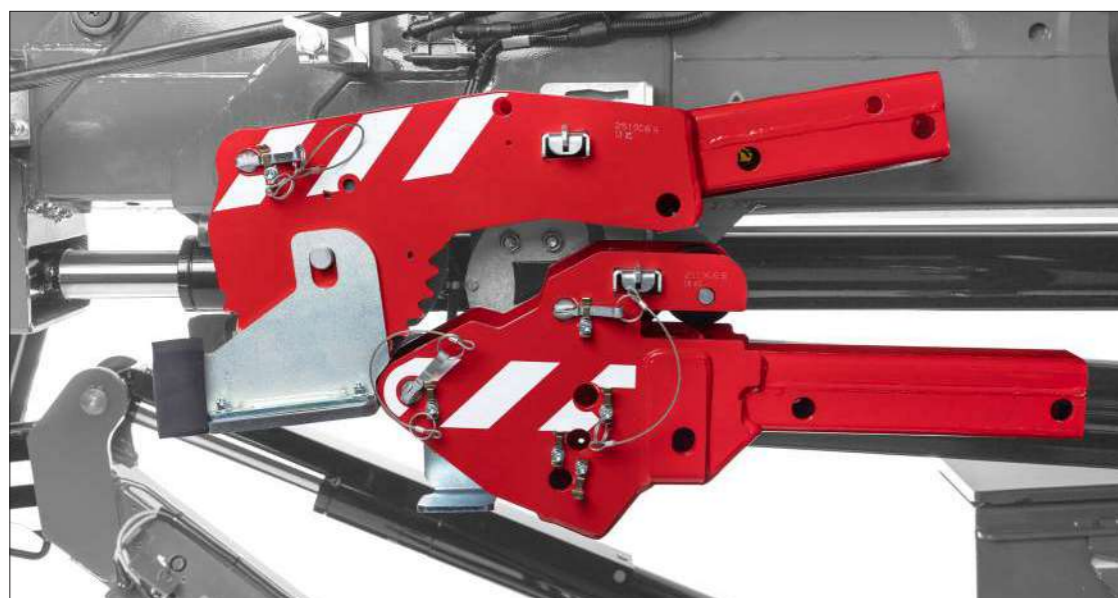

Remote control

- 1 Frequency of the crane.
- 2 Position of outriggers and capacity of the crane.
- 3 Remote control battery state of charge.
- 4 Height and outreach of the crane.
- 5 Weight hanging from the machine and the maximum capacity of the crane.
- 6 Load as percentage of crane capacity.

Outrigger pads

The C6e has four outrigger pads for the legs as standard. The dimensions of these outrigger pads are 300 x 300 mm.



Winch weight

The winch weight hangs at the front of the machine. The winch weight is 33 kg.



Operation

The lightweight remote has six paddle switches that provide very responsive control. The remote control can be used with either a neck or hip belt.



Retractable/extendable counterweight

The counterweight is hydraulically extendable and retractable. The capacity of the crane increases when the ballast is extended. The crane automatically knows whether the counterweight is extended or retracted.



Removable counterweight

The C6e's counterweight is removable. This makes it possible to reduce the weight of the crane by 600 kg. By also removing the jib, it is possible to reduce the crane's own weight to two tonnes.





Hoeflon and service **Solution guaranteed!**

Hoeflon stands for quality. In the unlikely event of a problem, we will solve it! Service is of paramount importance. The primary objective is ensuring that the crane is back in service as quickly as possible. Local service shops, service vans and trained service technicians are present in all markets that Hoeflon serves. This is your guarantee that you will be back to work in no time!

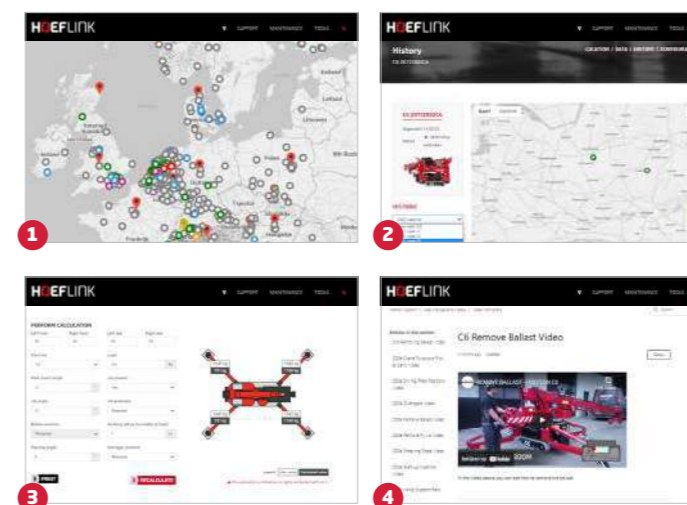
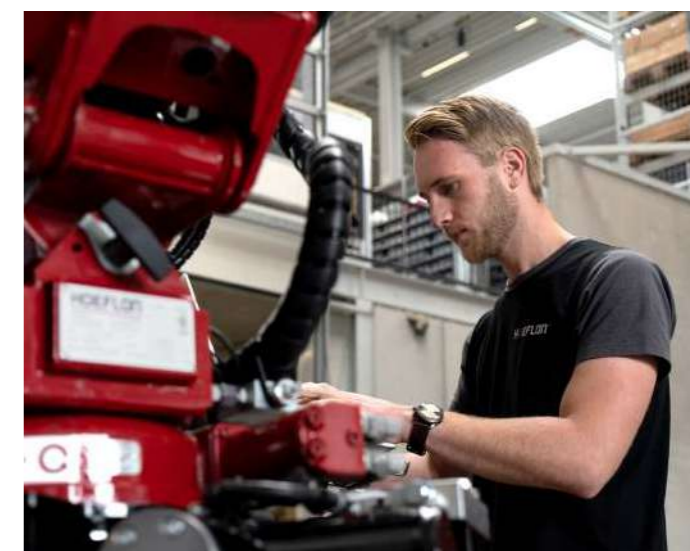

Hoeflink

- 1 Remote support
- 2 Up to three weeks of history available for review.
- 3 Calculate the outrigger pressure of each machine for every situation.
- 4 Access to the Hoeflon support database with explanatory videos, user manuals and more.

Interested?

Then watch a demo at one of our dealers!



Hoeflon dealers

Hoeflon is represented on all continents. This means you have a personal point of contact. You can always reach out to them for purchase and service. Communication is always in your own language.

Call one of our dealers for more information on the C6e, or one of the other Hoeflon cranes. You can also make an appointment for a comprehensive demo.

We look forward to your visit!



C6e

The unique all-rounder!

Hoeflon International B.V.

Zwolleweg 2

3771 NR Barneveld, NL

T 0342 400288

sales@hoeflon.com

KVK 66408962

BIC ABNANL2A

BTW NL856539806B01

IBAN NL96ABNA0457114533

www.hoeflon.com